

Product data sheet

Characteristics

9070T500D31

Transformer, Type T, industrial control, 500 VA,
240/480 VAC pri / 120/240 VAC second, 1 phase,
50/60 Hz, 115 °C rise



Product availability: Stock - Normally stocked in distribution facility

Price*: 509.00 USD



Main

Product or component type	Industrial Control Transformer
Rated power in VA	500 VA
Range of product	T

Complementary

Phase	1 phase
Rated power in VA	500 VA UL 500 VA CSA 500 VA NOM 300 VA
Temperature rise	115 °C
Electrical connection	Screw clamp terminals
Height	3.84 In (97.54 mm)
Width	4.5 In (114.30 mm)
Depth	5.49 In (139.45 mm)
Material	Copper winding
Product compatibility	FSC2

Environment

Product certifications	UL listed file E61239 CSA file LR37055 guide 184-N-90
NEMA degree of protection	Not rated (open device)
Insulation temperature	356 °F (180 °C)

Ordering and shipping details

Category	16201 - 9070 T (NOT TF) 250-2000VA
Discount Schedule	CP8
GTIN	00785901907206
Nbr. of units in pkg.	1
Package weight(Lbs)	12.34 Lb(US) (5.597 kg)
Returnability	Yes
Country of origin	MX

Packing Units

Unit Type of Package 1	PCE
Package 1 Height	6.50 In (16.51 cm)
Package 1 width	6.70 In (17.018 cm)
Package 1 Length	7.60 In (19.304 cm)

Offer Sustainability

Sustainable offer status	Green Premium product
California proposition 65	WARNING: This product can expose you to chemicals including: Phenyl glycidyl ether, which is known to the State of California to cause cancer and birth defects or other reproductive harm. For more information go to www.P65Warnings.ca.gov
REACH Regulation	REACH Declaration
EU RoHS Directive	Compliant EU RoHS Declaration
Mercury free	Yes
RoHS exemption information	Yes
China RoHS Regulation	China RoHS Declaration
Environmental Disclosure	Product Environmental Profile
PVC free	Yes

Contractual warranty

Warranty	10 Years
----------	----------

Approximate Dimensions

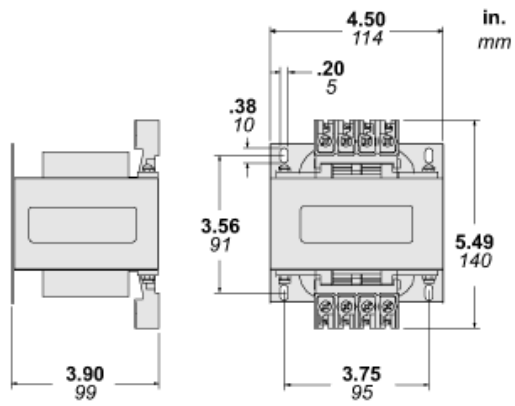

Connections and Wiring Diagrams

Voltage and Connection Options

Voltage Code	Voltages		Connections	
	Primary	Secondary	Primary	Secondary
D31	220 x 440 230 x 460 240 x 480	110/220 115/230 120/240	220 or 230 or 240: Connect to H1 and H4 Jumper H1 with H3 Jumper H2 with H4 440 or 460 or 480: Connect to H1 and H4 Jumper H2 with H3	110 or 115 or 120: Connect to X1 and X4 Jumper X1 with X3 Jumper X2 with X4 220 or 230 or 240: Connect to X1 and X4 Jumper X2 with X3
D55	110 x 220 115 x 230 120 x 240	110 x 220 115 x 230 120 x 240	110 or 115 or 120: Connect to H1 and H4 Jumper H1 with H3 Jumper H2 with H4 220 or 230 or 240: Connect to H1 and H4 Jumper H2 with H3	110 or 115 or 120: Connect to X1 and X4 Jumper X1 with X3 Jumper X2 with X4 220 or 230 or 240: Connect to X1 and X4 Jumper X2 with X3

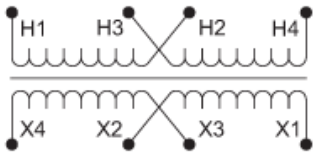

Product Life Status : **Commercialised**